



TIP132 TIP135 TIP137

COMPLEMENTARY SILICON POWER DARLINGTON TRANSISTORS

- STMicroelectronics PREFERRED SALESTYPES

APPLICATION

- LINEAR AND SWITCHING INDUSTRIAL EQUIPMENT

DESCRIPTION

The TIP132 is a silicon Epitaxial-Base NPN power transistor in monolithic Darlington configuration, mounted in Jedec TO-220 plastic package. It is intended for use in power linear and switching applications.

The complementary PNP type is TIP137 .

Also TIP135 is a PNP type.



ABSOLUTE MAXIMUM RATINGS

Symbol	Parameter	Value		Unit
		NPN	TIP132	
		PNP	TIP137	
V _{CBO}	Collector-Base Voltage (I _E = 0)	60	100	V
V _{CEO}	Collector-Emitter Voltage (I _B = 0)	60	100	V
V _{EBO}	Emitter-Base Voltage (I _C = 0)	5		V
I _C	Collector Current	8		A
I _{CM}	Collector Peak Current	12		A
I _B	Base Current	0.3		A
P _{tot}	Total Dissipation at T _{case} ≤ 25 °C T _{amb} ≤ 25 °C	70		W
		2		W
T _{stg}	Storage Temperature	-65 to 150		°C
T _j	Max. Operating Junction Temperature	150		°C

* For PNP types voltage and current values are negative.

TIP132 / TIP135 / TIP137

THERMAL DATA

R _{thj-case}	Thermal Resistance Junction-case	Max	1.78	°C/W
R _{thj-amb}	Thermal Resistance Junction-ambient	Max	63.5	°C/W

ELECTRICAL CHARACTERISTICS (T_{case} = 25 °C unless otherwise specified)

Symbol	Parameter	Test Conditions	Min.	Typ.	Max.	Unit
I _{CEO}	Collector Cut-off Current (I _B = 0)	V _{CE} = Half Rated V _{CEO}			0.5	mA
I _{CBO}	Collector Cut-off Current (I _E = 0)	V _{CB} = Rated V _{CBO}			0.2	mA
I _{EBO}	Emitter Cut-off Current (I _C = 0)	V _{EB} = 5 V			5	mA
V _{CEO(sus)} *	Collector-Emitter Sustaining Voltage (I _B = 0)	I _C = 30 mA for TIP135 for TIP132/TIP137	60 100			V V
V _{CE(sat)} *	Collector-Emitter Saturation Voltage	I _C = 4 A I _C = 6 A			2 4	V V
V _{BE} *	Base-Emitter Voltage	I _C = 4 A V _{CE} = 4 V			2.5	V
h _{FE} *	DC Current Gain	I _C = 1 A I _C = 4 A	500 1000		15000	

* Pulsed: Pulse duration = 300 μs, duty cycle 1.5 %
For PNP types voltage and current values are negative.

Safe Operating Areas

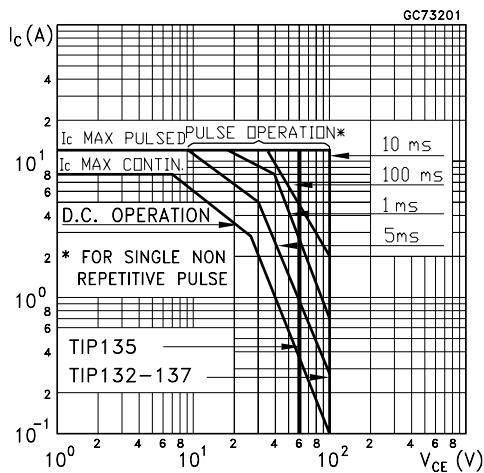

Power Derating Curve

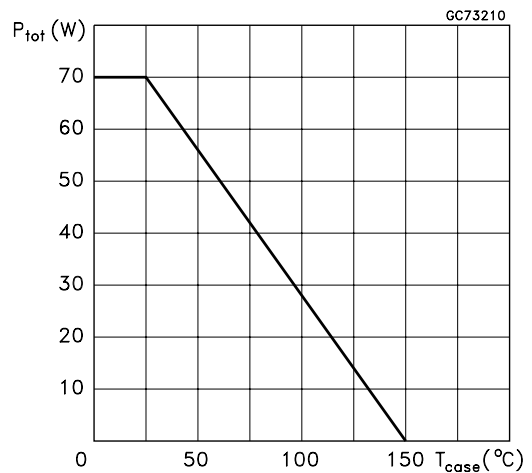

TO-220 MECHANICAL DATA

DIM.	mm			inch		
	MIN.	TYP.	MAX.	MIN.	TYP.	MAX.
A	4.40		4.60	0.173		0.181
C	1.23		1.32	0.048		0.051
D	2.40		2.72	0.094		0.107
D1		1.27			0.050	
E	0.49		0.70	0.019		0.027
F	0.61		0.88	0.024		0.034
F1	1.14		1.70	0.044		0.067
F2	1.14		1.70	0.044		0.067
G	4.95		5.15	0.194		0.203
G1	2.4		2.7	0.094		0.106
H2	10.0		10.40	0.393		0.409
L2		16.4			0.645	
L4	13.0		14.0	0.511		0.551
L5	2.65		2.95	0.104		0.116
L6	15.25		15.75	0.600		0.620
L7	6.2		6.6	0.244		0.260
L9	3.5		3.93	0.137		0.154
DIA.	3.75		3.85	0.147		0.151

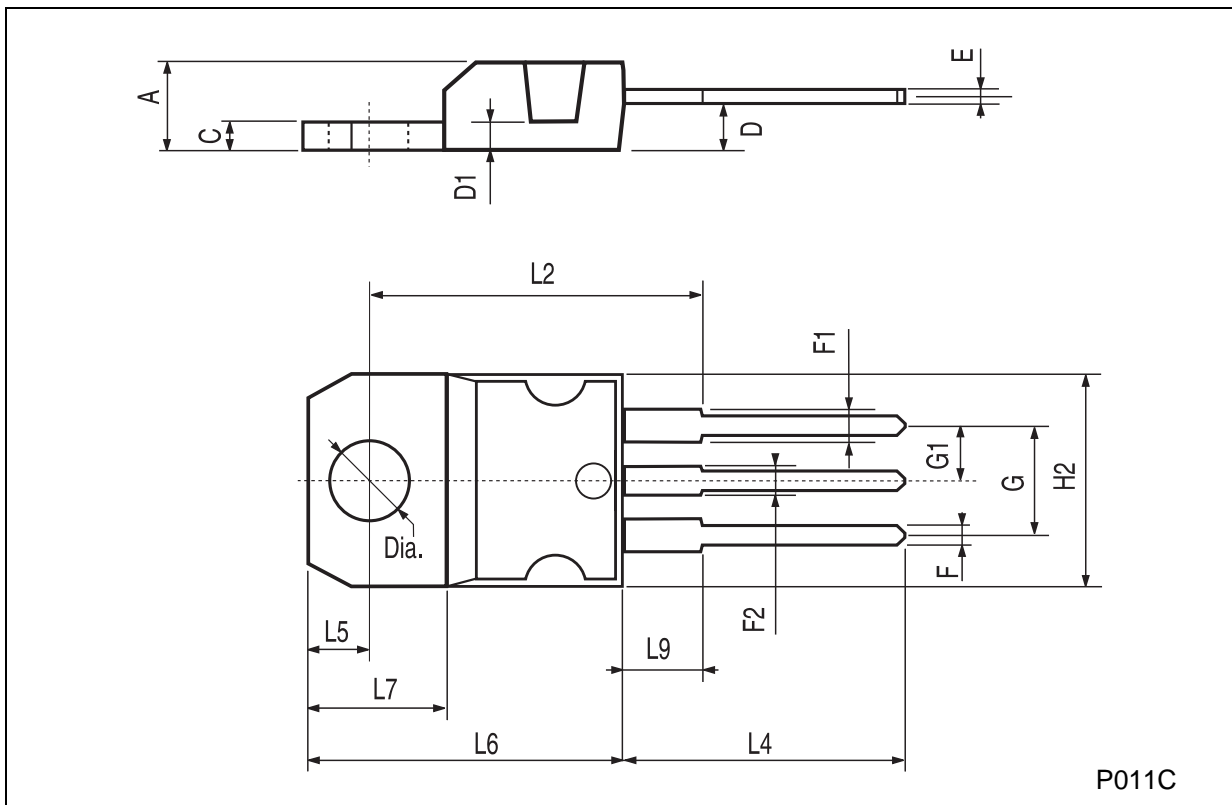

P011C

Information furnished is believed to be accurate and reliable. However, STMicroelectronics assumes no responsibility for the consequences of use of such information nor for any infringement of patents or other rights of third parties which may result from its use. No license is granted by implication or otherwise under any patent or patent rights of STMicroelectronics. Specification mentioned in this publication are subject to change without notice. This publication supersedes and replaces all information previously supplied. STMicroelectronics products are not authorized for use as critical components in life support devices or systems without express written approval of STMicroelectronics.

The ST logo is a trademark of STMicroelectronics

© 1999 STMicroelectronics – Printed in Italy – All Rights Reserved
STMicroelectronics GROUP OF COMPANIES

Australia - Brazil - China - Finland - France - Germany - Hong Kong - India - Italy - Japan - Malaysia - Malta - Morocco -
Singapore - Spain - Sweden - Switzerland - United Kingdom - U.S.A.

<http://www.st.com>